

Incremental encoders

Solid shaft with square flange

100...5000 pulses per revolution

EIL580 - square flange - *OptoPulse®*



EIL580 with square flange

Features

- Size $\varnothing 58$ mm
- Precise optical sensing
- Output signal level TTL or HTL
- Square flange 63.5 x 63.5 mm
- Connection axial, radial or tangential
- Pulses per revolution up to 5000
- High protection up to IP 67
- High resistance to shock and vibrations

Technical data - electrical ratings

Voltage supply	5 VDC ± 5 % 8...30 VDC 4.75...30 VDC
Reverse polarity protection	Yes
Short-circuit proof	Yes (HTL) Yes (TTL, max. 1 s and 1 signal)
Consumption w/o load	≤ 70 mA
Pulses per revolution	100...5000
Phase shift	$90^\circ \pm 10^\circ$
Scan ratio	40...60 %
Reference signal	Zero pulse, width $90^\circ \pm 10$ %
Sensing method	Optical
Output frequency	≤ 300 kHz (TTL) ≤ 160 kHz (HTL)
Output signals	A+, B+, R+, A-, B-, R-
Output stages	TTL/RS422 HTL/push-pull
Interference immunity	DIN EN 61000-6-2
Emitted interference	DIN EN 61000-6-3
Approval	UL 508 / CSA 22.2

Technical data - mechanical design

Size (flange)	63.5 x 63.5 mm
Shaft type	$\varnothing 10$ x 20 mm, solid shaft with edge $\varnothing 9.525$ mm (3/8") x 20 mm, solid shaft with edge
Admitted shaft load	≤ 40 N axial ≤ 80 N radial
Flange	Clamping flange square 63.5 x 63.5 mm
Protection DIN EN 60529	IP 65 (without shaft seal), IP 67 (with shaft seal)
Operating speed	≤ 6000 rpm (+20 °C, IP 67) ≤ 12000 rpm (+20 °C, IP 65)
Starting torque	≤ 0.015 Nm (+20 °C, IP 65) ≤ 0.02 Nm (+20 °C, IP 67)
Materials	Housing: aluminium die-cast Flange: aluminium Solid shaft: stainless steel
Operating temperature	-40...+85 °C
Relative humidity	90 % non-condensing
Resistance	DIN EN 60068-2-6 Vibration 30 g, 10-2000 Hz DIN EN 60068-2-27 Shock 300 g, 6 ms
Connection	Flange connector M12, 8-pin Flange connector M23, 12-pin Cable
Weight approx.	370 g

Incremental encoders

Solid shaft with square flange

100...5000 pulses per revolution

EIL580 - square flange - *OptoPulse*®

Part number

Square flange

EIL580-S **Q** **A**

Pulse number - see table

Voltage supply / output stages

- E 5 VDC, TTL/RS422, 6 channel
- H 8...30 VDC, TTL/RS422, 6 channel
- N 8...30 VDC, HTL/push-pull, 6 channel
- Q 4.75...30 VDC, HTL/push-pull, 6 channel

Connection

- R Cable radial, 1 m
- L Cable radial, 2 m
- F Flange connector M23, 12-pin, radial, male, ccw
- B Flange connector M12, 8-pin, radial, male, ccw
- T Cable axial, 1 m
- U Cable axial, 2 m
- D Flange connector M23, 12-pin, axial, male, ccw
- A Flange connector M12, 8-pin, axial, male, ccw
- P Cable tangential, 1 m
- Q Cable tangential, 2 m

Protection

- 5 IP 65
- 7 IP 67

Specification solid shaft

- U3 $\varnothing 9.525$ mm (3/8") x 20 mm, with edge
- 10 $\varnothing 10$ x 20 mm, with edge

Flange

- Q Square flange

Pulse number

100	300	720	1250	2500
120	360	800	1440	3000
150	400	900	1500	3600
200	500	1000	1800	4000
250	512	1024	2000	4096
256	600	1200	2048	5000

Incremental encoders

Solid shaft with square flange

100...5000 pulses per revolution

EIL580 - square flange - *OptoPulse*[®]

Accessories

Connectors and cables

10127844	Connection cable 2 m shielded with female connector M12, 8-pin, straight (ESG 34FH0200G)
10129332	Connection cable 5 m shielded with female connector M12, 8-pin, straight (ESG 34FH0500G)
10129333	Connection cable 10 m shielded with female connector M12, 8-pin, straight (ESG 34FH1000G)
11053961	Connection cable 2 m shielded with female connector M12, 8-pin, angled (ESW 33FH0200G)
11053962	Connection cable 5 m shielded with female connector M12, 8-pin, angled (ESW 33FH0500G)
10170054	Connection cable 10 m shielded with female connector M12, 8-pin, angled (ESW 33FH1000G)
10164705	Connector M23, 12-pin
11095302	Connection cable 1 m shielded with female connector M23, 12-pin
11100408	Connection cable 2 m shielded with female connector M23, 12-pin
11100430	Connection cable 5 m shielded with female connector M23, 12-pin
11100431	Connection cable 10 m shielded with female connector M23, 12-pin

Mounting accessories

11065915	Coupling CPS25 L=19 d1=04/d2=10
11065918	Coupling CPS25 L=19 d1=07/d2=10
11065920	Coupling CPS25 L=19 d1=08/d2=10
11065921	Coupling CPS25 L=19 d1=09/d2=10
11065922	Coupling CPS25 L=19 d1=10/d2=06
11065923	Coupling CPS25 L=19 d1=10/d2=10
11065924	Coupling CPS25 L=19 d1=10/d2=11
11065925	Coupling CPS25 L=19 d1=10/d2=12
10141132	Spring washer coupling D1=06 / D2=10
10141133	Spring washer coupling D1=10 / D2=10
11034138	Spring washer coupling D1=10 / D2=16
11034140	Spring washer coupling D1=10 / D2=14
11034141	Spring washer coupling D1=10 / D2=12
11050507	Bellows coupling aluminium/stainless steel D1=06 / D2=10
11101781	Double loops coupling D1=10 / D2=10

Incremental encoders

Solid shaft with square flange

100...5000 pulses per revolution

EIL580 - square flange - OptoPulse®

Output signals

Clockwise rotating direction when looking at flange.

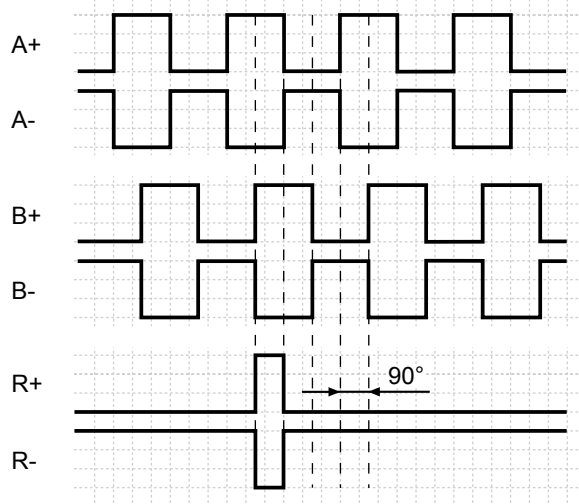

Trigger level

Outputs	TTL/RS422
Output level High	≥ 2.5 V
Output level Low	≤ 0.5 V
Load	≤ 20 mA

Outputs	HTL/Push-pull
Output level High	$\geq U_B - 3$ V
Output level Low	≤ 1.5 V
Load	≤ 20 mA

Terminal assignment

Flange connector M23, 12-pin / cable

Pin	Core color	Assignment
1	pink	B-
2	–	–
3	blue	R+
4	red	R-
5	green	A+
6	yellow	A-
7	–	–
8	grey	B+
9	–	–
10	white	GND
11	–	–
12	brown	UB

Screen: Connected to housing

Cable data: PVC, [4x2x0.14 mm²], bending radius >32.5 mm, outer diameter 6.5 mm

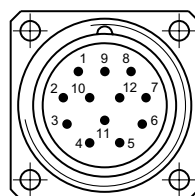

Flange connector M12, 8-pin

Pin	Assignment
1	GND
2	UB
3	A+
4	A-
5	B+
6	B-
7	R+
8	R-

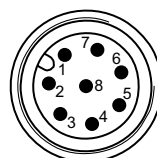

Incremental encoders

Solid shaft with square flange

100...5000 pulses per revolution

EIL580 - square flange - OptoPulse®

Dimensions

Square flange, flange connector M23, radial

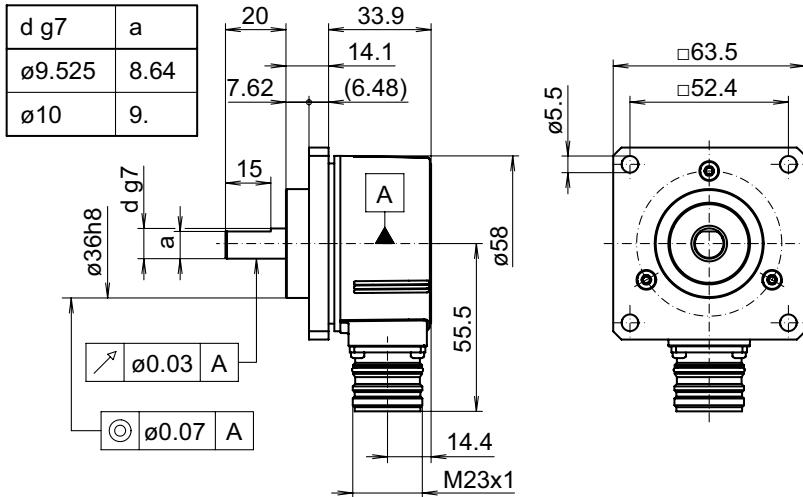

Square flange, flange connector M12, radial

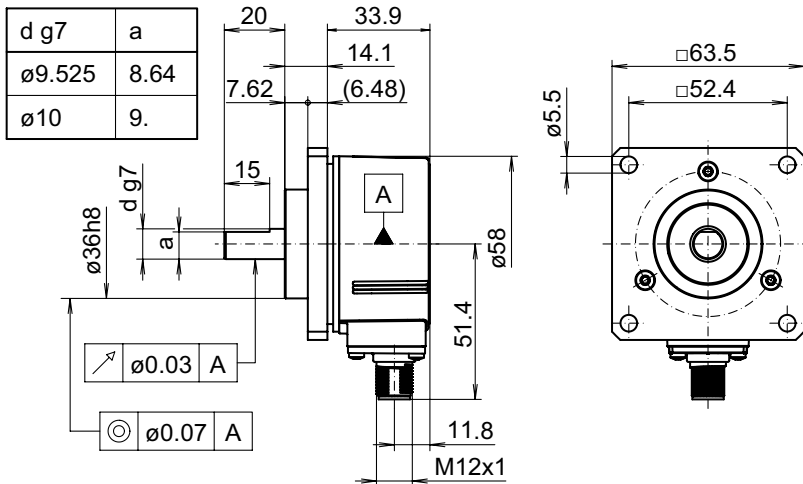

Square flange, cable radial

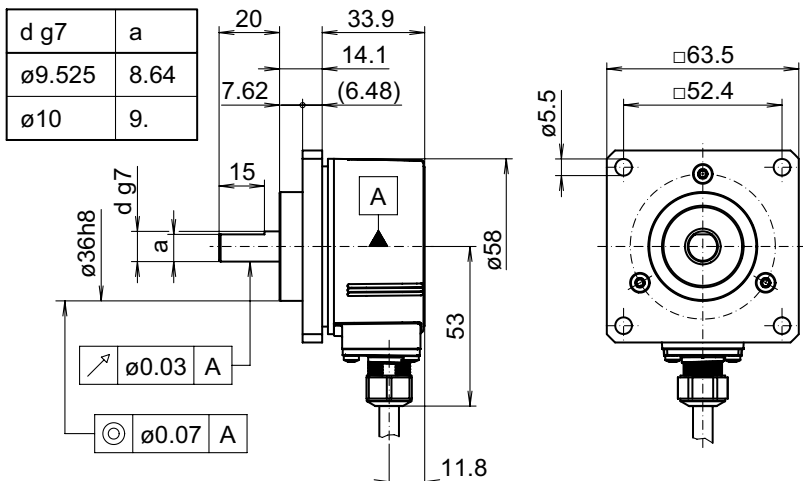

Incremental encoders

Solid shaft with square flange

100...5000 pulses per revolution

EIL580 - square flange - *OptoPulse®*

Dimensions

Square flange, flange connector M23, axial

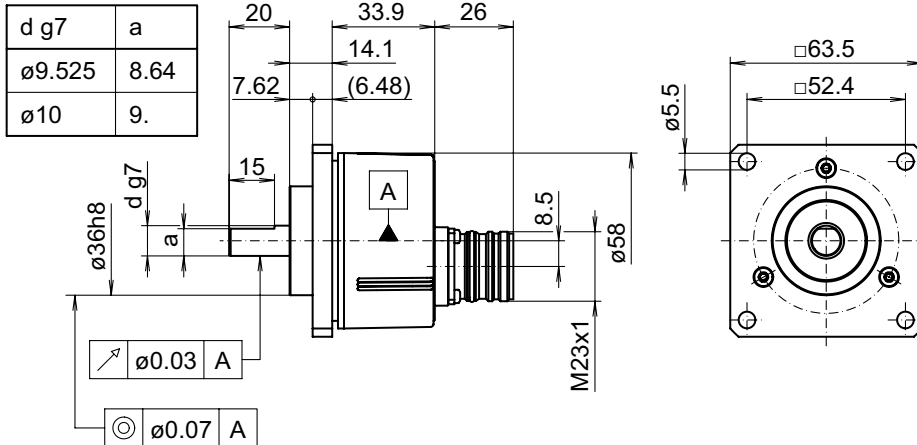

Square flange, flange connector M12, axial

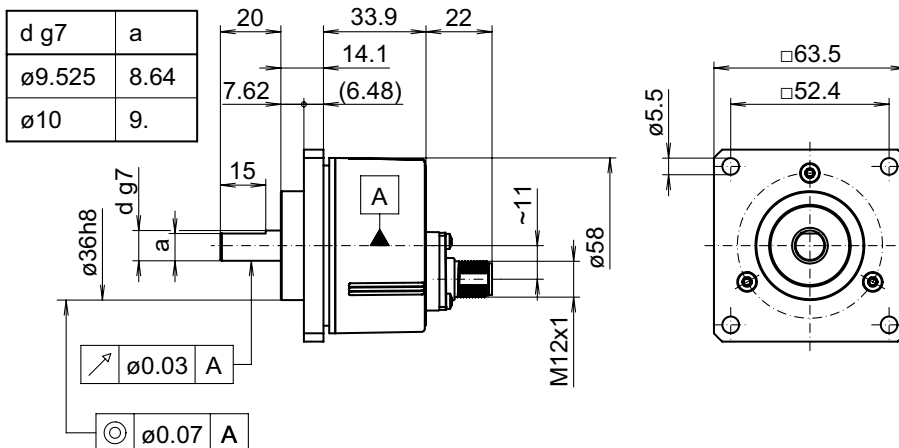

Square flange, cable axial

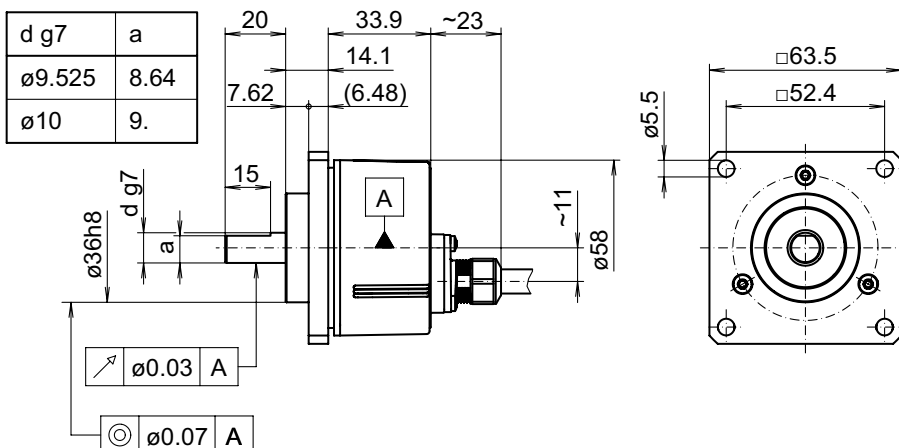

Incremental encoders

Solid shaft with square flange

100...5000 pulses per revolution

EIL580 - square flange - OptoPulse®

Dimensions

Square flange, cable tangential

